

Olympus

APPLICATION:

- Up light, Shadowing, Wall Wash, Silhouette, Architectural Accents

DESIGNED and CONSTRUCTED for MAXIMUM HEAT TRANSFER:

- 6061 Aluminum - Clear Anodized (SSA Model)
- 6061 Aluminum - High Performance Enamel (BLK Model)
- High Performance C360 Solid Brass (BR Model)
- Tempered Mineral Glass Protective Lens

LED LIFE EXPECTANCY (TM-21 data):

- Greater than 60,000 hours (greater than 20 years at 8 hours per day)

DRIVER SYSTEM:

- External Driver reduces heat while extending the life of electronic components

INPUT VOLTAGE:

- 10.5 ttt 1

INSTALLATION and HARDWARE:

- LV180 Ground Stake included
- All stainless steel hardware

LEAD WIRES:

- SPT-2 18 gauge Tinned wire, total lead length is 46"

ELECTRONICS WARRANTY:

- 20 Years

CERTIFICATION:

- UL1838 Low Voltage Landscape Lighting



BLK



BR



SSA

AVAILABLE FINISHES:

Black (BLK)

C360 Solid Brass (BR)

Stainless Aluminum (SSA)

LED DATA:

Triple LED Output - 3,000K CCT Warm White

2.2VA
1.3 Watts

10W
Halogen
Equivalent







5.4VA
3.7 Watts

20W
Halogen
Equivalent

10.4VA
8.3 Watts

35W
Halogen
Equivalent

How To Order (Choose 1 Item From Each Column) ex: V2354 BLK GRN

Model #	Wattage	Optics	Finish	Light Output
V2	10¹	1 (for 12°)	BLK BR SSA	White 
	20¹	2 (for 25°)		AMB² Amber 
	35	4 (for 40°)		BLU Blue 
		6 (for 60°)		RBL² Royal Blue 
				GRN Green 
				RED² Red 

- 1 All Colors are *Non-Stock Items* and may require up to a 5 - 7 day lead time
- 2 Noted Colors are *Non-Stock Items* and may require up to a 5 - 7 day lead time
- 3 Compatible when used with Crestron drivers, see page vi for more information

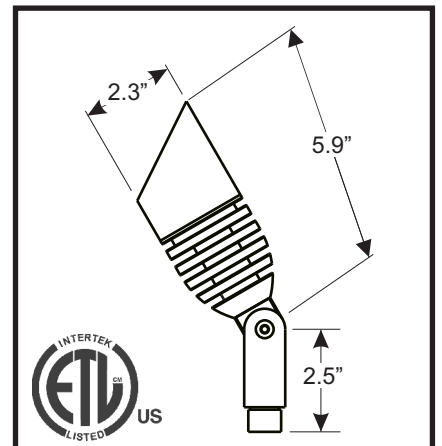

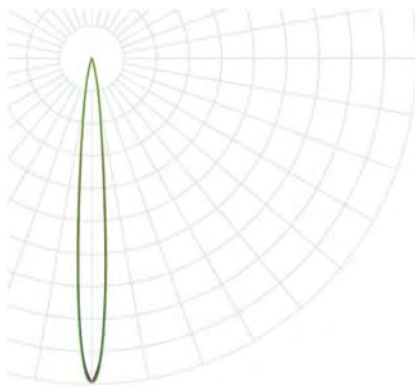

— C0
— C45
— C90

V2XX1

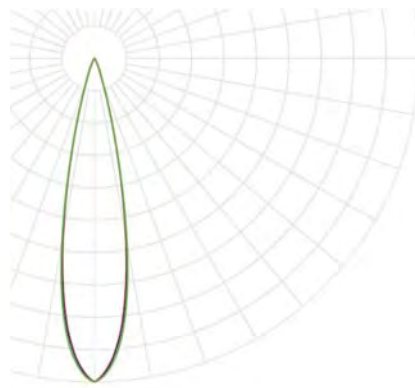

— C0
— C45
— C90

V2XX2

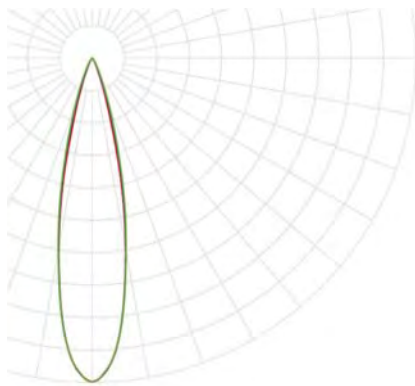

— C0
— C45
— C90

V2XX4

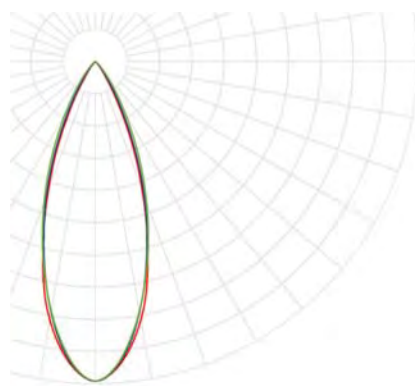

— C0
— C45
— C90

V2XX6